

Service
Service
Service



Service Manual

TABLE OF CONTENTS

	Page
Location of PCB Boards & version variation & repair scenario matrix.....	1-1
Production Specifications	1-2
Remote control	1-4
Brife guide	1-5
Safety Instruction, Warning & Notes.....	1-10
Mechanical and Dismantling Instructions	2-1
Software Version & Upgrades.....	3-1
Trouble Shooting Chart	4-1
Set Block & Wiring Diagrams	5-1
Electrical Diagrams and PCB layouts	6-1
Set Mechanical Exploded view	7-1
Revision List	8-1



© Copyright 2010 Philips Consumer Electronics B.V. Eindhoven, The Netherlands
All rights reserved. No part of this publication may be reproduced, stored in a retrieval system or transmitted, in any form or by any means, electronic, mechanical, photocopying, or otherwise without the prior permission of Philips.

Published by Helen-RY 1216 Service Audio Printed in The Netherlands Subject to modification

© 313978536210

Version 1.0

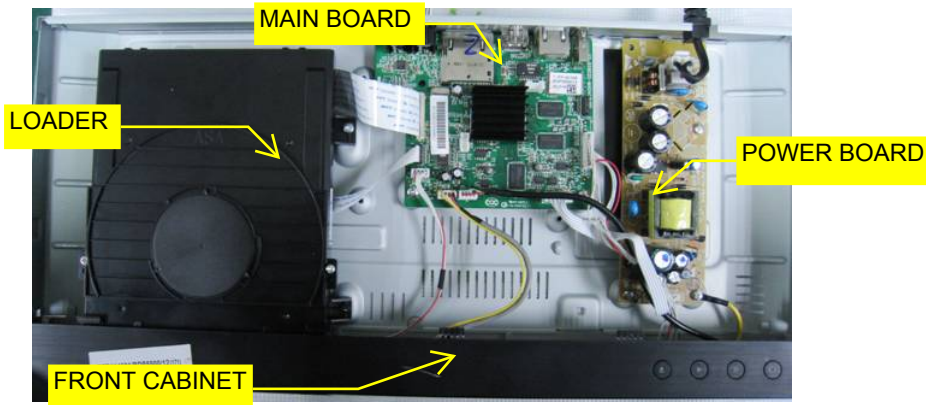

PHILIPS

PCB BOARD LOCATION:**Version Variation**

Type/Versions	BDP6100
Features	/12
Power supply rating:220-240V ,50Hz	X
Power consumption:20W	X

Repair Scenario Matrix

Type/Versions	BDP6100
Board in used	/12
Main Board	Bd
Power Board	Bd
Front Board	Bd
Loader	Bd

*Bd:Board Level Replacement

*C:Component Level Repair



Product Specifications:

Note

- Specifications are subject to change without notice

Region code

This player can play discs with the following region codes.

DVD	Blu-ray	Countries
 		Europe, United Kingdom

Playable media

- BD-Video, BD 3D
- DVD-Video, DVD+R/+RW, DVD-R/-RW, DVD+R/-R DL (Dual Layer)
- VCD/SVCD
- Audio CD, CD-R/CD-RW, MP3 media, WMA media, JPEG files
- DivX (Ultra)/DivX Plus HD media, MKV media
- USB storage device

File format

- Video: .avi, .divx, .mp4, .mkv, .wmv
- Audio: .mp3, .wma, .wav
- Picture: .jpg, .gif, .png

Video

- Signal system: PAL / NTSC
- Composite video output: 1 Vp-p (75 ohm)
- HDMI output: 480i/576i, 480p/576p, 720p, 1080i, 1080p, 1080p/24Hz

Audio

- 2 Channel analog output
 - Audio Front L&R : 2 Vrms (> 1 kohm)
- Digital output: 0.5 Vp-p (75 ohm)
 - Coaxial
- HDMI output
- Sampling frequency:
 - MP3: 32 kHz, 44.1 kHz, 48 kHz
 - WMA: 44.1 kHz, 48 kHz

- Constant bit rate:
 - MP3: 112 kbps - 320 kbps
 - WMA: 48 kbps - 192 kbps

USB

- Compatibility: Hi-Speed USB (2.0)
- Class support: USB Mass Storage Class
- File system: FAT16, FAT32
- USB port: 5V \pm , 500mA (for each port)
- Support HDD (a portable hard disc drive): an external power source may be needed.

Main unit

- Power supply rating: AC 220-240V~, 50 Hz
- Power consumption: 20 W
- Power consumption in standby mode (fast wakeup disabled): < 0.3 W
- Dimensions (w x h x d): 435 x 38 x 212.7 (mm)
- Net Weight: 1.53 kg

Accessories supplied

- Remote control and 2 AAA batteries
- User manual
- CD-ROM built in multi-lingual user manual (Continental Europe only)

Laser Specification

- Laser Type (Diode): AlGaInN (BD), AlGaInP (DVD/CD)
- Wave length: 398 ~ 412nm (BD), 650 ~ 664nm (DVD), 784 ~ 796nm (CD)
- Output power (Max ratings): 20mW (BD), 7mW (DVD), 7mW (CD)

Remote Control

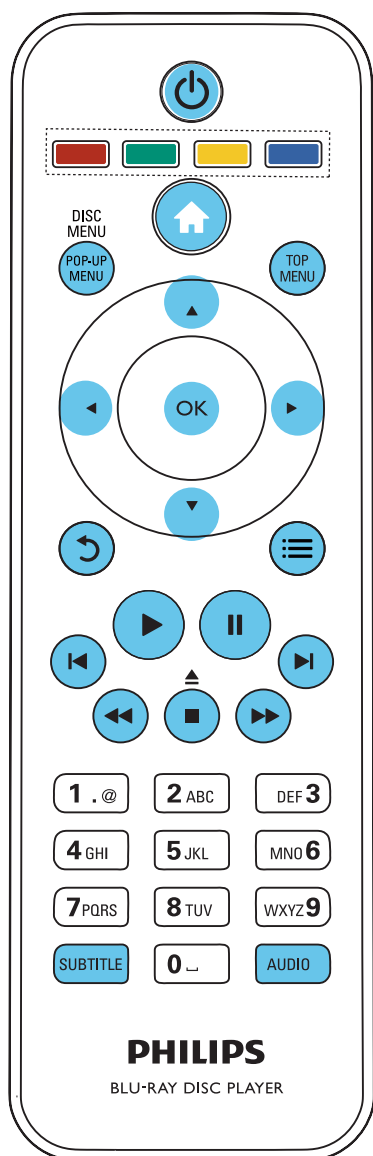

During play, press the following buttons to control.

Button	Action
	Turn on the player, or switch to standby.
	Access the home menu.
	Stop play. Press and hold (more than 4 seconds) to open or close the disc compartment.
	Pause play. Press repeatedly to slow forward frame by frame.
	Start or resume play.
	Skip to the previous or next track, chapter or file.
	Fast backward or forward. Press repeatedly to change the search speed. Press once, and then press to slow forward.
AUDIO	Select an audio language or channel.
SUBTITLE	Select a subtitle language.
DISC MENU / POP-UP MENU	Access or exit the disc menu.
TOP MENU	Access the main menu of a video disc.
Color buttons	Select tasks or options for Blu-ray discs.
	Navigate the menus. Press to rotate a picture clockwise or counter-clockwise during slideshow.
OK	Confirm a selection or entry.
	Return to a previous display menu.
	Access more options during play.



Brief Guide

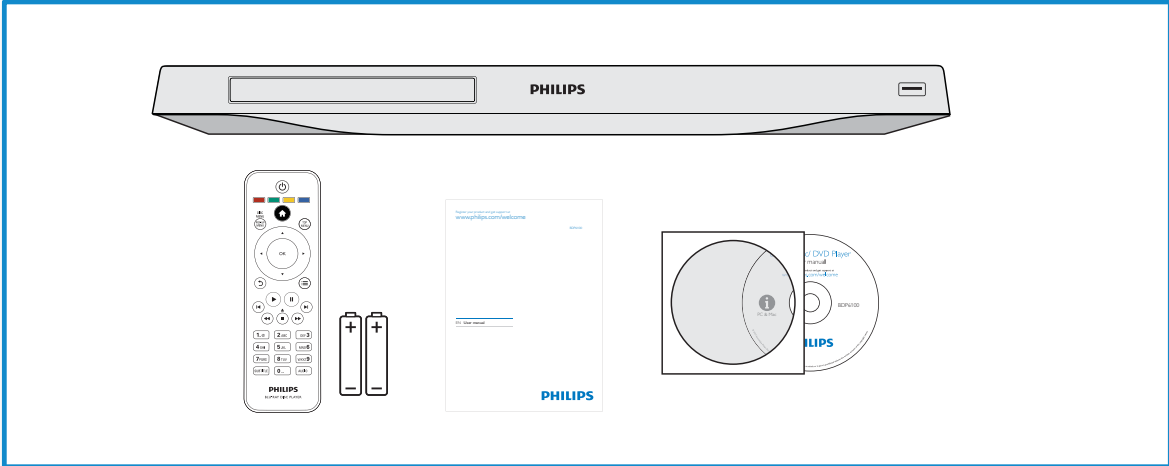

1

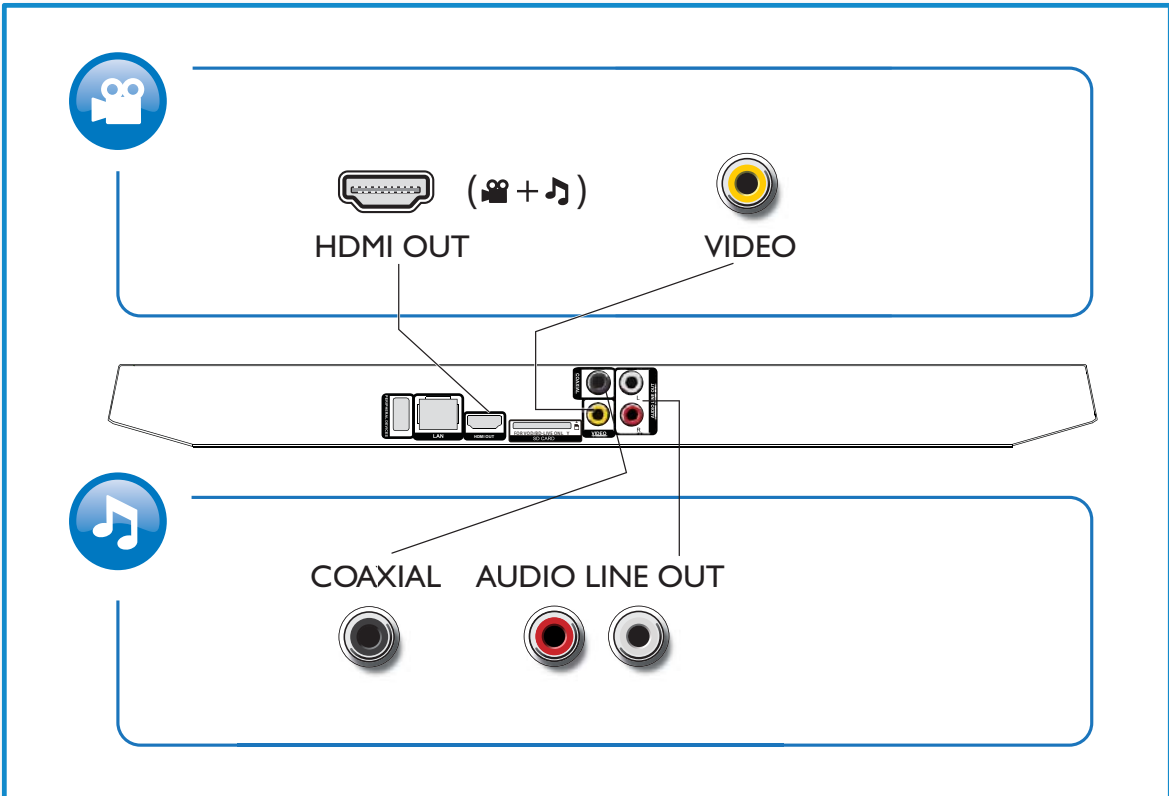

2



1 HDMI



HDMI VIDEO COAXIAL AUDIO LINE OUT

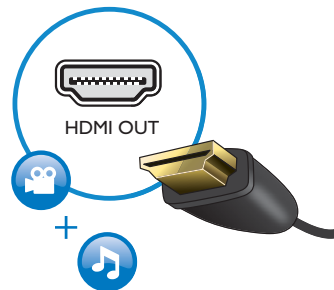

2 VIDEO+AUDIO LINE OUT



HDMI VIDEO COAXIAL AUDIO LINE OUT

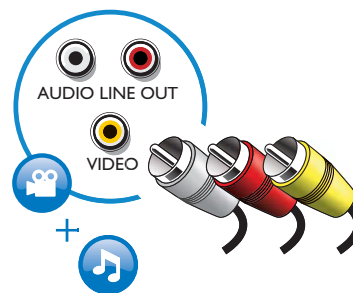

3 COAXIAL

HDMI VIDEO COAXIAL AUDIO LINE OUT

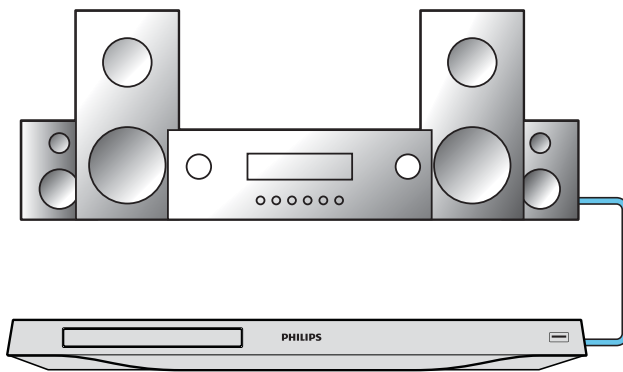

4 AUDIO LINE OUT

HDMI VIDEO COAXIAL AUDIO LINE OUT

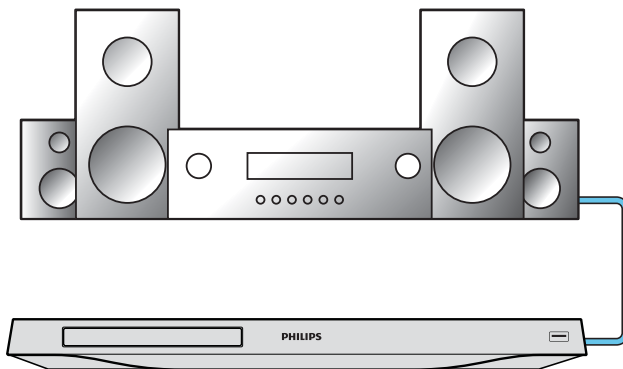

3

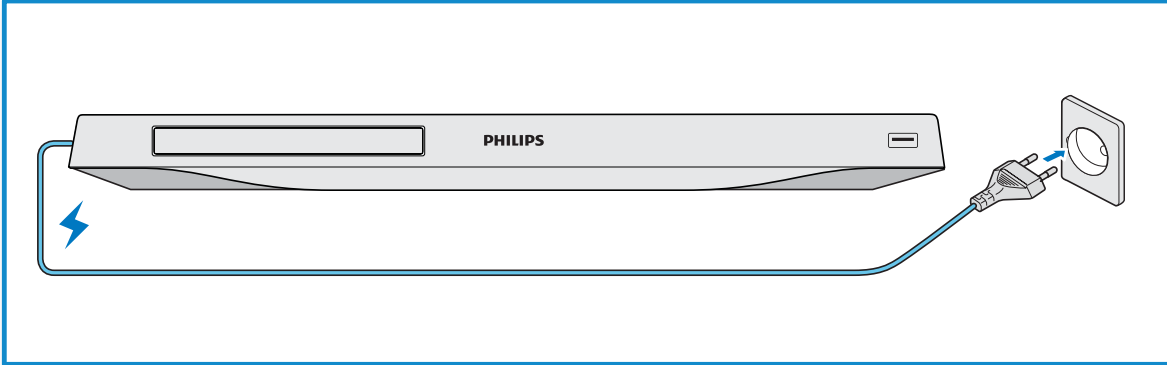

4

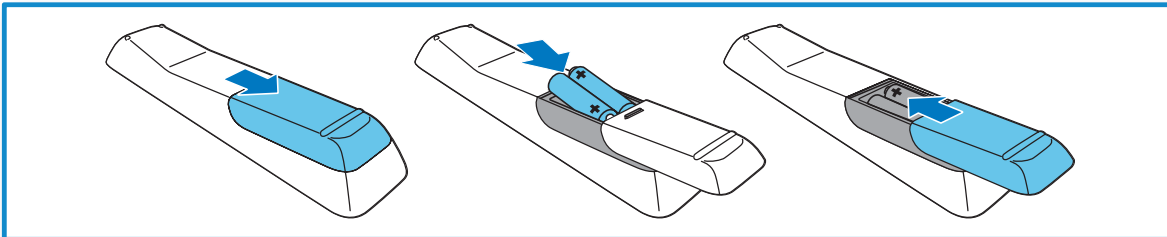

5

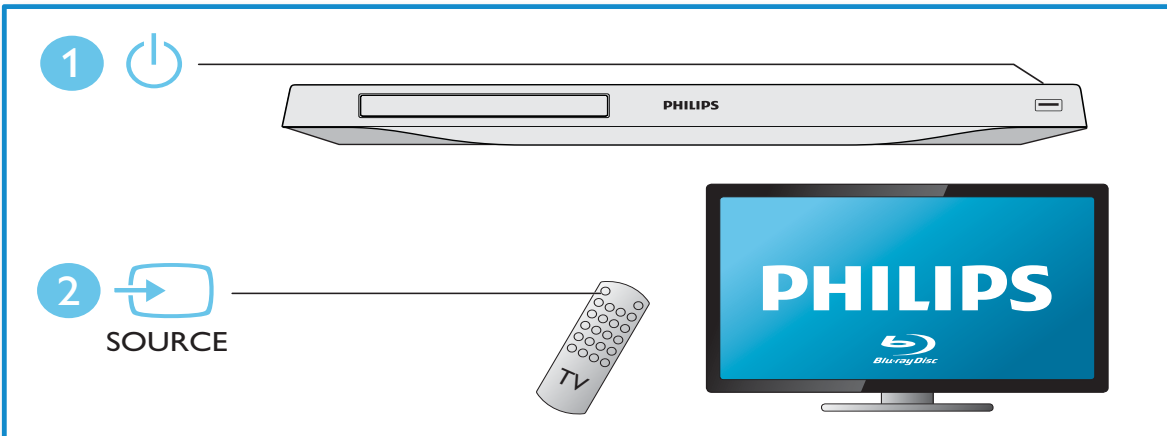

6



2

BD/BD 3D
DVD/VCD/CD
DivX Plus HD/MKV
MP3 / JPEG

1



3

4

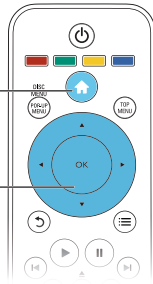

1

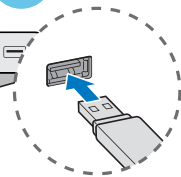

2

3

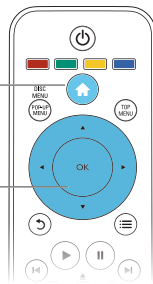

2. Safety Instructions, Warnings, Notes, and Abbreviation List

Index of this chapter:

[2.1 Safety Instructions](#)

[2.2 Warnings](#)

[2.3 Notes](#)

[2.4 Abbreviation List](#)

2.1 Safety Instructions

Safety regulations require the following **during** a repair:

- Connect the set to the Mains/AC Power via an isolation transformer (> 800 VA).
- Replace safety components, indicated by the symbol ▲, only by components identical to the original ones. Any other component substitution (other than original type) may increase risk of fire or electrical shock hazard.

Safety regulations require that **after** a repair, the set must be returned in its original condition. Pay in particular attention to the following points:

- Route the wire trees correctly and fix them with the mounted cable clamps.
- Check the insulation of the Mains/AC Power lead for external damage.
- Check the strain relief of the Mains/AC Power cord for proper function.
- Check the electrical DC resistance between the Mains/AC Power plug and the secondary side (only for sets that have a Mains/AC Power isolated power supply):
 1. Unplug the Mains/AC Power cord and connect a wire between the two pins of the Mains/AC Power plug.
 2. Set the Mains/AC Power switch to the "on" position (keep the Mains/AC Power cord unplugged!).
 3. Measure the resistance value between the pins of the Mains/AC Power plug and the metal shielding of the tuner or the aerial connection on the set. The reading should be between 4.5 MΩ and 12 MΩ.
 4. Switch "off" the set, and remove the wire between the two pins of the Mains/AC Power plug.
- Check the cabinet for defects, to prevent touching of any inner parts by the customer.

2.2 Warnings

- All ICs and many other semiconductors are susceptible to electrostatic discharges (ESD ⚡). Careless handling during repair can reduce life drastically. Make sure that, during repair, you are connected with the same potential as the mass of the set by a wristband with resistance. Keep components and tools also at this same potential.
- Be careful during measurements in the high voltage section.
- Never replace modules or other components while the unit is switched "on".
- When you align the set, use plastic rather than metal tools. This will prevent any short circuits and the danger of a circuit becoming unstable.

2.3 Notes

2.3.1 General

- Measure the voltages and waveforms with regard to the chassis (= tuner) ground (⊥), or hot ground (↕), depending on the tested area of circuitry. The voltages and waveforms shown in the diagrams are indicative. Measure them in the Service Default Mode (see chapter 5) with a colour bar signal and stereo sound (L: 3 kHz, R: 1 kHz unless stated otherwise) and picture carrier at 475.25 MHz for PAL, or 61.25 MHz for NTSC (channel 3).

- Where necessary, measure the waveforms and voltages with (⊥) and without (↕) aerial signal. Measure the voltages in the power supply section both in normal operation (⊕) and in stand-by (⊖). These values are indicated by means of the appropriate symbols.

2.3.2 Schematic Notes

- All resistor values are in ohms, and the value multiplier is often used to indicate the decimal point location (e.g. 2K2 indicates 2.2 kΩ).
- Resistor values with no multiplier may be indicated with either an "E" or an "R" (e.g. 220E or 220R indicates 220 Ω).
- All capacitor values are given in micro-farads ($\mu = \times 10^{-6}$), nano-farads ($n = \times 10^{-9}$), or pico-farads ($p = \times 10^{-12}$).
- Capacitor values may also use the value multiplier as the decimal point indication (e.g. 2p2 indicates 2.2 pF).
- An "asterisk" (*) indicates component usage varies. Refer to the diversity tables for the correct values.
- The correct component values are listed in the Spare Parts List. Therefore, always check this list when there is any doubt.

2.3.3 BGA (Ball Grid Array) ICs

Introduction

For more information on how to handle BGA devices, visit this URL: www.atyourservice.ce.philips.com (needs subscription, not available for all regions). After login, select "Magazine", then go to "Repair downloads". Here you will find Information on how to deal with BGA-ICs.

BGA Temperature Profiles

For BGA-ICs, you **must** use the correct temperature-profile, which is coupled to the 12NC. For an overview of these profiles, visit the website www.atyourservice.ce.philips.com (needs subscription, but is not available for all regions)

You will find this and more technical information within the "Magazine", chapter "Repair downloads".

For additional questions please contact your local repair help desk.

2.3.4 Lead-free Soldering

Due to lead-free technology some rules have to be respected by the workshop during a repair:

- Use only lead-free soldering tin Philips SAC305 with order code 0622 149 00106. If lead-free solder paste is required, please contact the manufacturer of your soldering equipment. In general, use of solder paste within workshops should be avoided because paste is not easy to store and to handle.
- Use only adequate solder tools applicable for lead-free soldering tin. The solder tool must be able:
 - To reach a solder-tip temperature of at least 400°C.
 - To stabilize the adjusted temperature at the solder-tip.
 - To exchange solder-tips for different applications.
- Adjust your solder tool so that a temperature of around 360°C - 380°C is reached and stabilized at the solder joint. Heating time of the solder-joint should not exceed ~ 4 sec. Avoid temperatures above 400°C, otherwise wear-out of tips will increase drastically and flux-fluid will be destroyed. To avoid wear-out of tips, switch "off" unused equipment or reduce heat.
- Mix of lead-free soldering tin/parts with leaded soldering tin/parts is possible but PHILIPS recommends strongly to **avoid** mixed regimes. If this cannot be avoided, carefully clear the solder-joint from old tin and re-solder with new tin.

Safety Instructions, Warnings, Notes, and Abbreviation List

2.3.5 Alternative BOM identification

It should be noted that on the European Service website, "Alternative BOM" is referred to as "Design variant".

The **third digit** in the serial number (example: KX2B0835000001) indicates the number of the alternative B.O.M. (Bill Of Materials) that has been used for producing the specific AV set. In general, it is possible that the same AV model on the market is produced with e.g. two different types of display, coming from two different suppliers. This will then result in sets which have the same CTN (Commercial Type Number; e.g. MCM394/12) but which have a different B.O.M. number.

Also, it is possible that same model on the market is produced with two production centers, however their partslist is the same. In such case, no alternative B.O.M. will be created.

By looking at the third digit of the serial number, one can identify which B.O.M. is used for the set he is working with. If the third digit of the serial number contains the number "1" (example: KX1B033500001), then the set has been manufactured according to B.O.M. number 1. If the third digit is a "2" (example: KX2B033500001), then the set has been produced according to B.O.M. no. 2. This is important for ordering the correct spare parts!
For the third digit, the numbers 1...9 and the characters A...Z can be used, so in total: 9 plus 26= 35 different B.O.M.s can be indicated by the third digit of the serial number.

Identification: The bottom line of a type plate gives a 14-digit serial number. Digits 1 and 2 refer to the production centre (e.g. LM is Arts), digit 3 refers to the B.O.M. code, digit 4 refers to the Service version change code, digits 5 and 6 refer to the production year, and digits 7 and 8 refer to production week (in example below it is 2008 week 50). The 6 last digits contain the serial number.



Figure 2-1 Serial number (example)

2.3.6 Module Level Repair (MLR) or Component Level Repair (CLR)

If a board is defective, consult your repair procedure to decide if the board has to be exchanged or if it should be repaired on component level.

If your repair procedure says the board should be exchanged completely, do not solder on the defective board. Otherwise, it cannot be returned to the O.E.M. supplier for back charging!

2.3.7 Practical Service Precautions

- **It makes sense to avoid exposure to electrical shock.** While some sources are expected to have a possible dangerous impact, others of quite high potential are of limited current and are sometimes held in less regard.
- **Always respect voltages.** While some may not be dangerous in themselves, they can cause unexpected reactions that are best avoided. Before reaching into a powered TV set, it is best to test the high voltage insulation. It is easy to do, and is a good service precaution.

2.4 Abbreviation List

0/6/12	SCART switch control signal on AV board. 0 = loop through (AUX to TV), 6 = play 16 : 9 format, 12 = play 4 : 3 format
2DNR	Spatial (2D) Noise Reduction
3DNR	Temporal (3D) Noise Reduction
AARA	Automatic Aspect Ratio Adaptation: algorithm that adapts aspect ratio to remove horizontal black bars; keeps the original aspect ratio
ACI	Automatic Channel Installation: algorithm that installs TV channels directly from a cable network by means of a predefined TXT page
ADC	Analogue to Digital Converter
AFC	Automatic Frequency Control: control signal used to tune to the correct frequency
AGC	Automatic Gain Control: algorithm that controls the video input of the feature box
AM	Amplitude Modulation
ANR	Automatic Noise Reduction: one of the algorithms of Auto TV
AP	Asia Pacific
AR	Aspect Ratio: 4 by 3 or 16 by 9
ASF	Auto Screen Fit: algorithm that adapts aspect ratio to remove horizontal black bars without discarding video information
ATSC	Advanced Television Systems Committee, the digital TV standard in the USA
ATV	See Auto TV
Auto TV	A hardware and software control system that measures picture content, and adapts image parameters in a dynamic way
AV	External Audio Video
AVC	Audio Video Controller
AVIP	Audio Video Input Processor
B/G	Monochrome TV system. Sound carrier distance is 5.5 MHz
BLR	Board-Level Repair
BTSC	Broadcast Television Standard Committee. Multiplex FM stereo sound system, originating from the USA and used e.g. in LATAM and AP-NTSC countries
B-TXT	Blue TeleteXT
C	Centre channel (audio)
CEC	Consumer Electronics Control bus: remote control bus on HDMI connections
CL	Constant Level: audio output to connect with an external amplifier
CLR	Component Level Repair
COLUMBUS	COLOR LUMinance Baseband Universal Sub-system
ComPair	Computer aided rePair
CP	Connected Planet / Copy Protection
CSM	Customer Service Mode
CTI	Color Transient Improvement: manipulates steepness of chroma transients
CVBS	Composite Video Blanking and Synchronization
DAC	Digital to Analogue Converter
DBE	Dynamic Bass Enhancement: extra low frequency amplification
DDC	See "E-DDC"

Safety Instructions, Warnings, Notes, and Abbreviation List

D/K	Monochrome TV system. Sound carrier distance is 6.5 MHz		lines. The fields are written in "pairs", causing line flicker.
DFI	Dynamic Frame Insertion	IR	Infra Red
DFU	Directions For Use: owner's manual	IRQ	Interrupt Request
DMR	Digital Media Reader: card reader	ITU-656	The ITU Radio communication Sector (ITU-R) is a standards body subcommittee of the International Telecommunication Union relating to radio communication. ITU-656 (a.k.a. SDI), is a digitized video format used for broadcast grade video.
DMSD	Digital Multi Standard Decoding		Uncompressed digital component or digital composite signals can be used.
DNM	Digital Natural Motion		The SDI signal is self-synchronizing, uses 8 bit or 10 bit data words, and has a maximum data rate of 270 Mbit/s, with a minimum bandwidth of 135 MHz.
DNR	Digital Noise Reduction: noise reduction feature of the set		
DRAM	Dynamic RAM		
DRM	Digital Rights Management		
DSP	Digital Signal Processing		
DST	Dealer Service Tool: special remote control designed for service technicians		
DTCP	Digital Transmission Content Protection; A protocol for protecting digital audio/video content that is traversing a high speed serial bus, such as IEEE-1394	ITV	Institutional TeleVision; TV sets for hotels, hospitals etc.
DVB-C	Digital Video Broadcast - Cable	JOP	Jaguar Output Processor
DVB-T	Digital Video Broadcast - Terrestrial	LS	Last Status; The settings last chosen by the customer and read and stored in RAM or in the NVM. They are called at start-up of the set to configure it according to the customer's preferences
DVD	Digital Versatile Disc		Latin America
DVI(-d)	Digital Visual Interface (d= digital only)	LATAM	Liquid Crystal Display
E-DDC	Enhanced Display Data Channel (VESA standard for communication channel and display). Using E-DDC, the video source can read the EDID information from the display.	LCD	Light Emitting Diode
EDID	Extended Display Identification Data (VESA standard)	LED	Monochrome TV system. Sound carrier distance is 6.5 MHz. L' is Band I, L is all bands except for Band I
EEPROM	Electrically Erasable and Programmable Read Only Memory	L/L'	Local REgression approximation noise reduction
EMI	Electro Magnetic Interference	LORE	LG.Philips LCD (supplier)
EPLD	Erasable Programmable Logic Device	LPL	Loudspeaker
EU	Europe	LS	Low Voltage Differential Signalling
EXT	EXTernal (source), entering the set by SCART or by cinches (jacks)	LVDS	Mega bits per second
FBL	Fast BLanking: DC signal accompanying RGB signals	Mbps	Monochrome TV system. Sound carrier distance is 4.5 MHz
FDS	Full Dual Screen (same as FDW)	M/N	Microprocessor without Interlocked Pipeline-Stages; A RISC-based microprocessor
FDW	Full Dual Window (same as FDS)	MIPS	Matrix Output Processor
FLASH	FLASH memory		Metal Oxide Silicon Field Effect Transistor, switching device
FM	Field Memory or Frequency Modulation	MOP	Motion Pictures Experts Group
FPGA	Field-Programmable Gate Array	MOSFET	Multi Platform InterFace
FTV	Flat TeleVision		MUTE Line
Gb/s	Giga bits per second	MPEG	Not Connected
G-TXT	Green TeleteXT	MPIF	Near Instantaneous Compounded Audio Multiplexing. This is a digital sound system, mainly used in Europe.
H	H_sync to the module	MUTE	Negative Temperature Coefficient, non-linear resistor
HD	High Definition	NC	National Television Standard Committee. Color system mainly used in North America and Japan. Color carrier NTSC M/N= 3.579545 MHz, NTSC 4.43= 4.433619 MHz (this is a VCR norm, it is not transmitted off-air)
HDD	Hard Disk Drive	NICAM	Non-Volatile Memory: IC containing TV related data such as alignments
HDCP	High-bandwidth Digital Content Protection: A "key" encoded into the HDMI/DVI signal that prevents video data piracy. If a source is HDCP coded and connected via HDMI/DVI without the proper HDCP decoding, the picture is put into a "snow vision" mode or changed to a low resolution. For normal content distribution the source and the display device must be enabled for HDCP "software key" decoding.	NTC	Open Circuit
HDMI	High Definition Multimedia Interface	NTSC	On Screen Display
HP	HeadPhone		On screen display Teletext and Control; also called Artistic (SAA5800)
I	Monochrome TV system. Sound carrier distance is 6.0 MHz		Project 50: communication protocol between TV and peripherals
I ² C	Inter IC bus		Phase Alternating Line. Color system mainly used in West Europe (color carrier= 4.433619 MHz) and South America (color carrier PAL M=
I ² D	Inter IC Data bus		
I ² S	Inter IC Sound bus		
IF	Intermediate Frequency		
Interlaced	Scan mode where two fields are used to form one frame. Each field contains half the number of the total amount of		

Safety Instructions, Warnings, Notes, and Abbreviation List

	3.575612 MHz and PAL N= 3.582056 MHz)	V	V-sync to the module
PCB	Printed Circuit Board (same as "PWB")	VCR	Video Cassette Recorder
PCM	Pulse Code Modulation	VESA	Video Electronics Standards Association
PDP	Plasma Display Panel	VGA	640x480 (4:3)
PFC	Power Factor Corrector (or Pre-conditioner)	VL	Variable Level out: processed audio output toward external amplifier
PIP	Picture In Picture	VSB	Vestigial Side Band; modulation method
PLL	Phase Locked Loop. Used for e.g. FST tuning systems. The customer can give directly the desired frequency	WYSIWYR	What You See Is What You Record: record selection that follows main picture and sound
POR	Power On Reset, signal to reset the uP		1280x768 (15:9)
Progressive Scan	Scan mode where all scan lines are displayed in one frame at the same time, creating a double vertical resolution.	WXGA	Quartz crystal
		XTAL	1024x768 (4:3)
PTC	Positive Temperature Coefficient, non-linear resistor	Y	Luminance signal
PWB	Printed Wiring Board (same as "PCB")	Y/C	Luminance (Y) and Chrominance (C) signal
PWM	Pulse Width Modulation	YPbPr	Component video. Luminance and scaled color difference signals (B-Y and R-Y)
QRC	Quasi Resonant Converter		Component video
QTNR	Quality Temporal Noise Reduction	YUV	
QVCP	Quality Video Composition Processor		
RAM	Random Access Memory		
RGB	Red, Green, and Blue. The primary color signals for TV. By mixing levels of R, G, and B, all colors (Y/C) are reproduced.		
RC	Remote Control		
RC5 / RC6	Signal protocol from the remote control receiver		
RESET	RESET signal		
ROM	Read Only Memory		
R-TXT	Red TeleteXT		
SAM	Service Alignment Mode		
S/C	Short Circuit		
SCART	Syndicat des Constructeurs d'Appareils Radiorécepteurs et Téléviseurs		
SCL	Serial Clock I ² C		
SCL-F	CLock Signal on Fast I ² C bus		
SD	Standard Definition		
SDA	Serial Data I ² C		
SDA-F	DAta Signal on Fast I ² C bus		
SDI	Serial Digital Interface, see "ITU-656"		
SDRAM	Synchronous DRAM		
SECAM	SEequence Couleur Avec Mémoire. Color system mainly used in France and East Europe. Color carriers= 4.406250 MHz and 4.250000 MHz		
SIF	Sound Intermediate Frequency		
SMPS	Switched Mode Power Supply		
SoC	System on Chip		
SOG	Sync On Green		
SOPS	Self Oscillating Power Supply		
S/PDIF	Sony Philips Digital InterFace		
SRAM	Static RAM		
SRP	Service Reference Protocol		
SSB	Small Signal Board		
STBY	STand-BY		
SVGA	800x600 (4:3)		
SVHS	Super Video Home System		
SW	Software		
SWAN	Spatial temporal Weighted Averaging Noise reduction		
SXGA	1280x1024		
TFT	Thin Film Transistor		
THD	Total Harmonic Distortion		
TMDS	Transmission Minimized Differential Signalling		
TXT	TeleteXT		
TXT-DW	Dual Window with TeleteXT		
UI	User Interface		
uP	Microprocessor		
UXGA	1600x1200 (4:3)		

Mechanical and Dismantling Instructions

Dismantling Instruction

Detailed information please refer to the model set.

The following guidelines show how to dismantle the player.

Step1: Remove 4 screws around the Top Cover, and then remove the Top Cover (Figure 1).

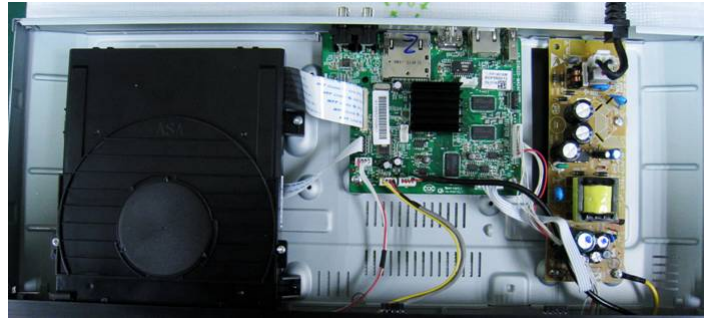

Figure 1

Step2: If it is necessary to dismantle Loader or Front Panel, the Front door should be removed first. (Figure 2)

Note: Make sure to operate gently otherwise the guider would be damaged.



Please kindly note that dismantle the front door assembly carefully to avoid damage tray and the front door.

Figure 2

Mechanical and Dismantling Instructions

Detailed information please refer to the model set.

Dismantling Instruction

Step3: Dismantling Front Panel, disconnect the connectors (XP5, XP2,XP4)(Figure 3)
Then Remove1 PCS Screw away(Figure 3)

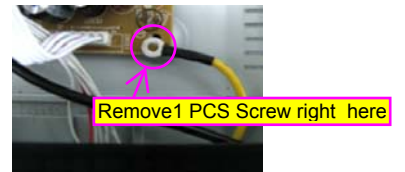
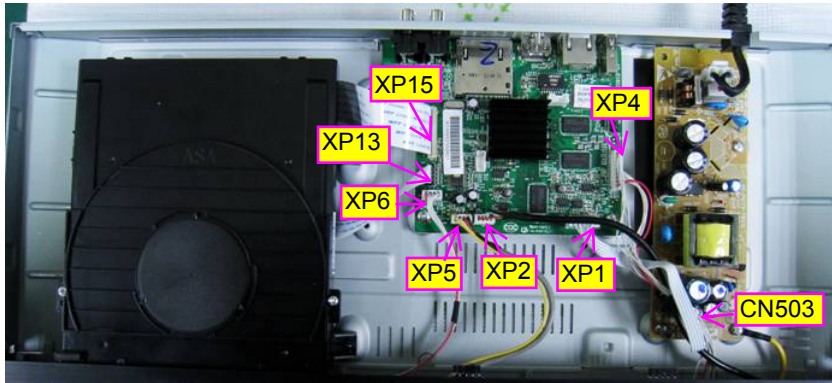

Figure 3

Step4: Dismantling Front Panel, need release 2 snaps of Front Panel and 2 snaps of bottom cabinet , then gently pull the Panel out from the set. (Figure 4)



Figure 4

Mechanical and Dismantling Instructions

Dismantling Instruction

Detailed information please refer to the model set.

Step5: Dismantling Loader, disconnect the 3 connectors (XP15,XP13,XP6)(Figure 3)aiming in the below figure, and remove 2 screws . (Figure 5)

Step6:Dismantling WIFI Board, need release 1 snap of WIFI Board , then gently pull the Panel out from the set. (Figure 5)

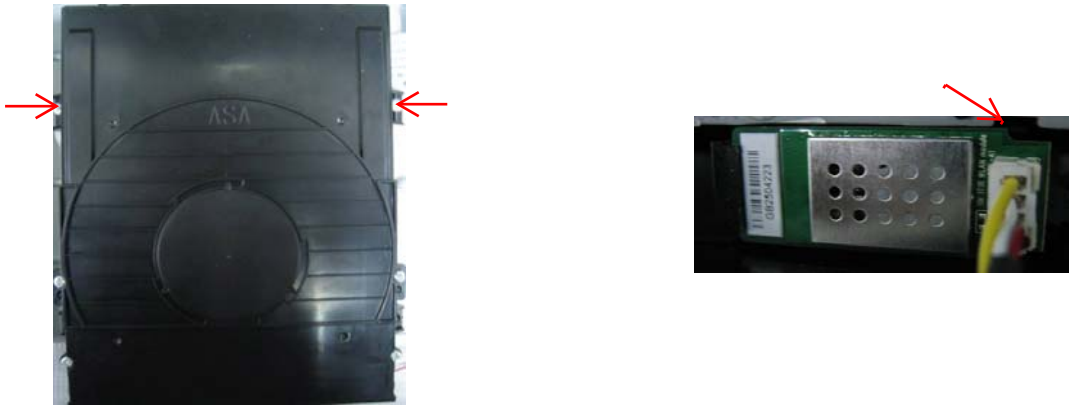

Figure 5

Step7: Dismantling Main Board , first disconnect the connector (XP4), and then remove 4 screws. (Figure 6)

Step8:Dismantling Power Board , first disconnect the connector (XP1),and then remove 3 screws. (Figure 6)

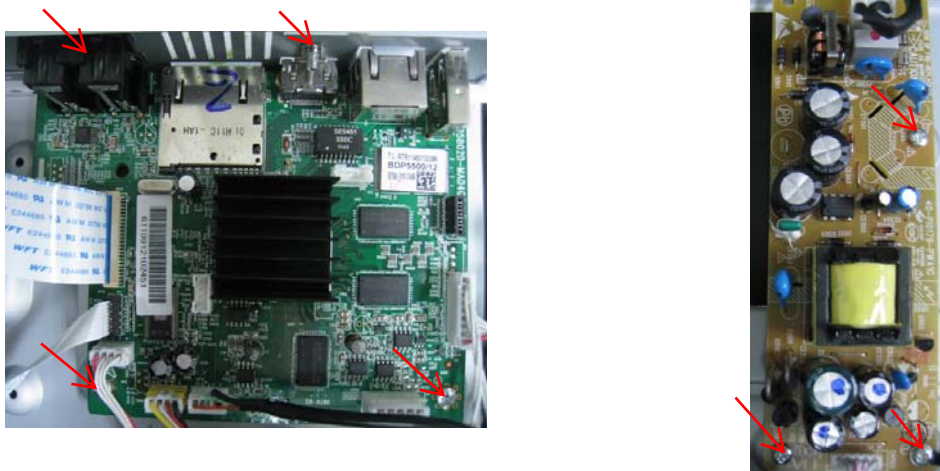

Figure 6

Software check and upgrade

Preparation to upgrade software

- 1) Start the CD burning software & create a folder named "UPG_ALL",
- 2) Then copy the Bin file (BDP6100.bin) into it,
- 3) Burn the data onto the blank CD or USB.

A. Procedure for software upgrade

A) Upgrade software via Disc

- 1) Power on the set and insert the prepared Upgrade CD.
- 2) The set will start reading disc & response with the following display TV screen:
Now searching for upgrade software!
Please wait!
3) Wait for a few seconds, then screen will display:
Software upgrade for this player have been found. Do you want to upgrade?(choosing "Cancel" or "Start" shows on TV set)

- 4) Press Right cursor button to choose "Start", then press <OK>;
- 5) The software will upgrade and screen will display as below:
Upgrade is ongoing, Please wait.
Please do not unplug or switch off the device.
- 6) The screen will display as below when upgrading complete:
Upgrade has completed successfully!

Power off after 5s.

Software BE:Passed
Software FE:Passed

- 5) Restart the set. (choosing "Restart" shows on TV set)

B) Upgrade software via network:

- 1) Setup the network connection (See "Getting started">"Set up network").
- 2) In the Home menu, select <Setting>-<Advanced Setup>-<Software Download>-<Network>.
* You are prompted to start upgrading processes if upgrade media is detected.
- 3) Follow the instructions on the TV screen to confirm update operation.
* Once software update is complete, this player automatically turns to reboot.

C) Update software via USB Flash Drive:

- 1) Go to www.philips.com/support to check if the latest software version is available for this player.
- 2) Download the software onto a USB flash drive.
- 3) Insert the USB flash drive to the USB jack of the rear panel.
- 4) In the Home menu, select <Setup>-<Advanced Setup>-<Software Update>-<USB>.
- 5) Follow the instructions on the TV screen to confirm update operation.
* Once software update is complete, this player automatically turns to reboot.

B. Read out the software versions to confirm upgrading

- 1) Power on the set.
- 2) Press <Home> button on the remote control.
- 3) Select <Setup>, then press <OK>.
- 4) Select <Advanced Setup>, press right cursor to choose <Version Info.>, then press <OK>, the software version and other information will display on the TV screen as below:

Model:BDP6100

Versions:

System SW: XXX

Ethernet MAC:XX-XX-XX-XX-XX-XX

Wireless MAC:XX-XX-XX-XX-XX-XX

For Information, frequently asked questions and software updates, visit www.philips.com/support

Caution: The set must not be power off during upgrading, otherwise the Main board will be damaged entirely.

No display on LED, and buttons do not work

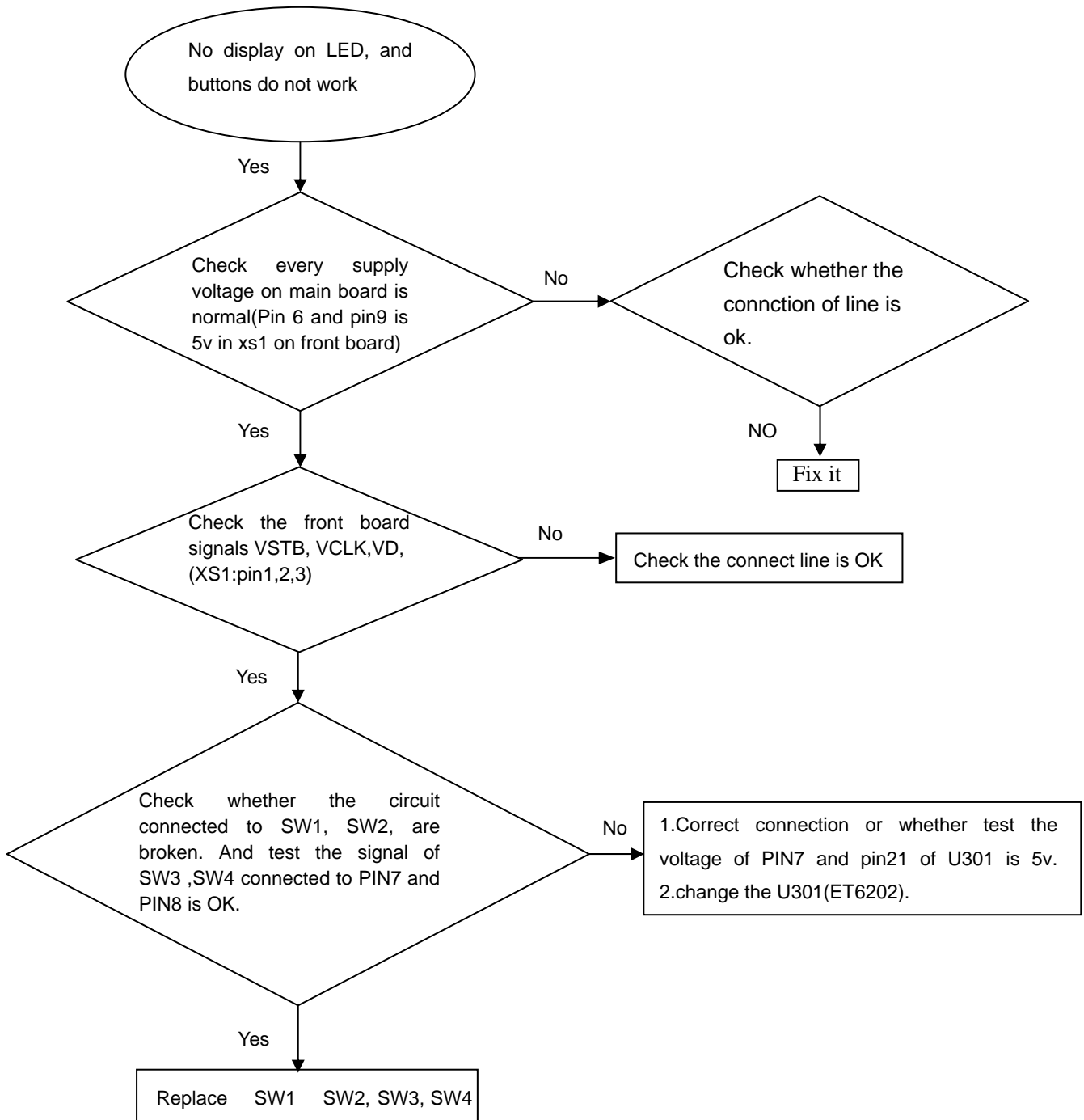

No audio output

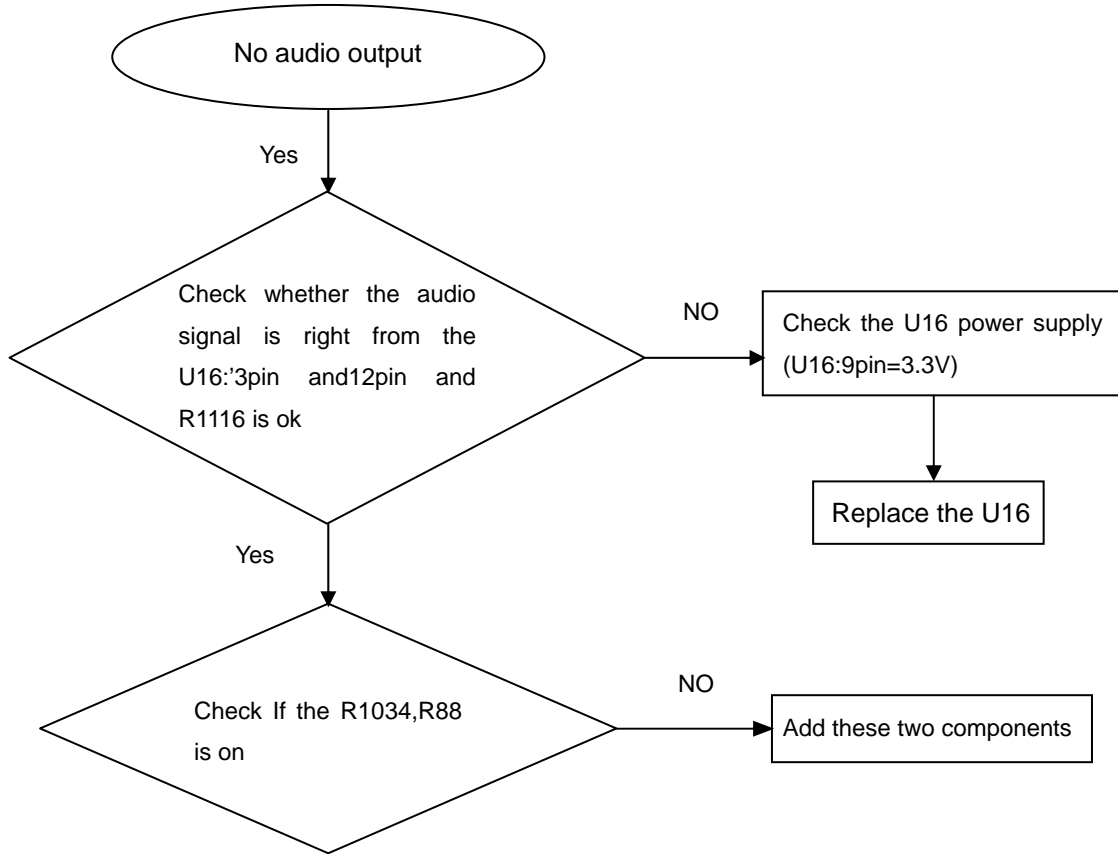

Remote control does not work

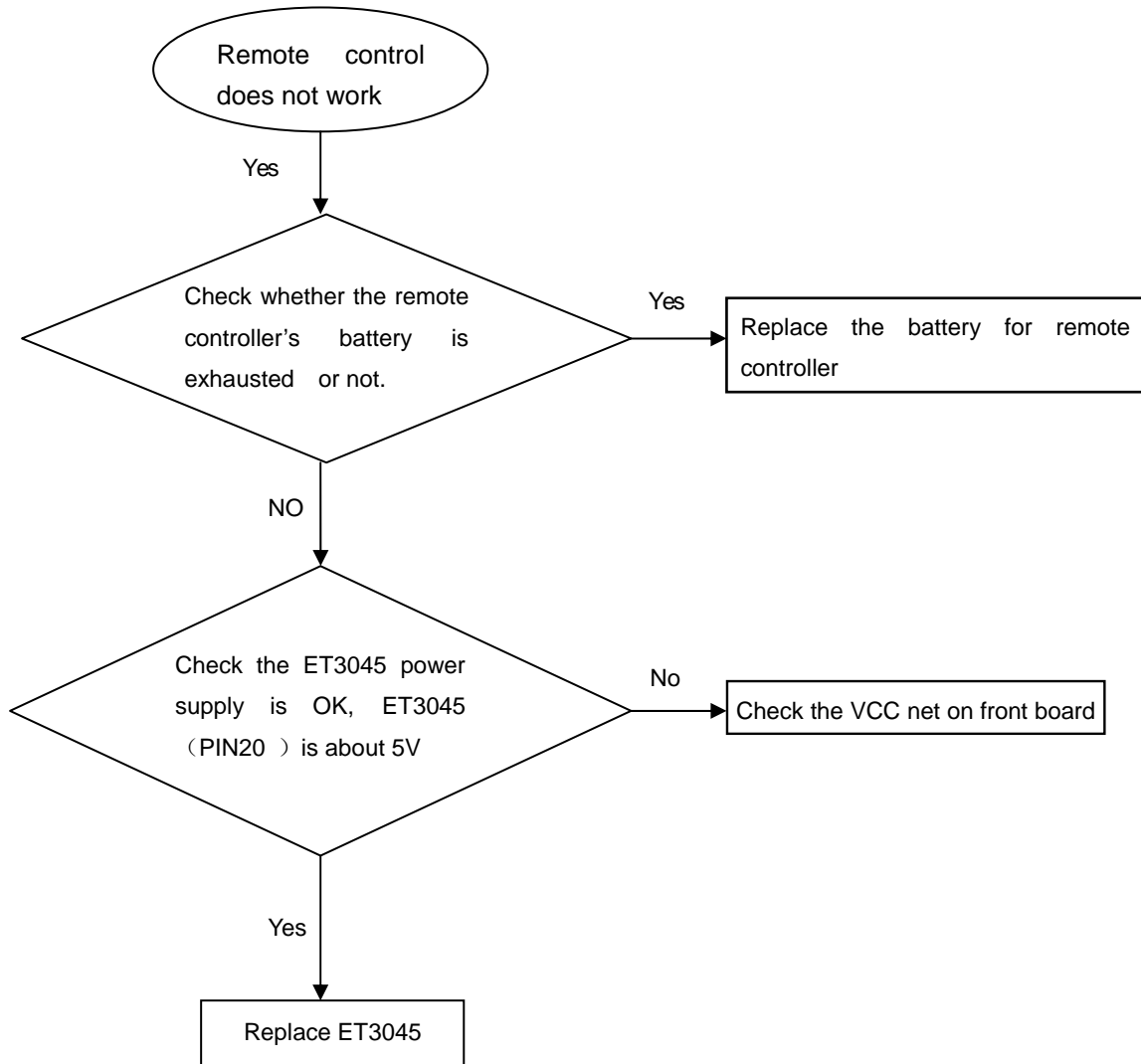

Can't read disc or can't open the disk door

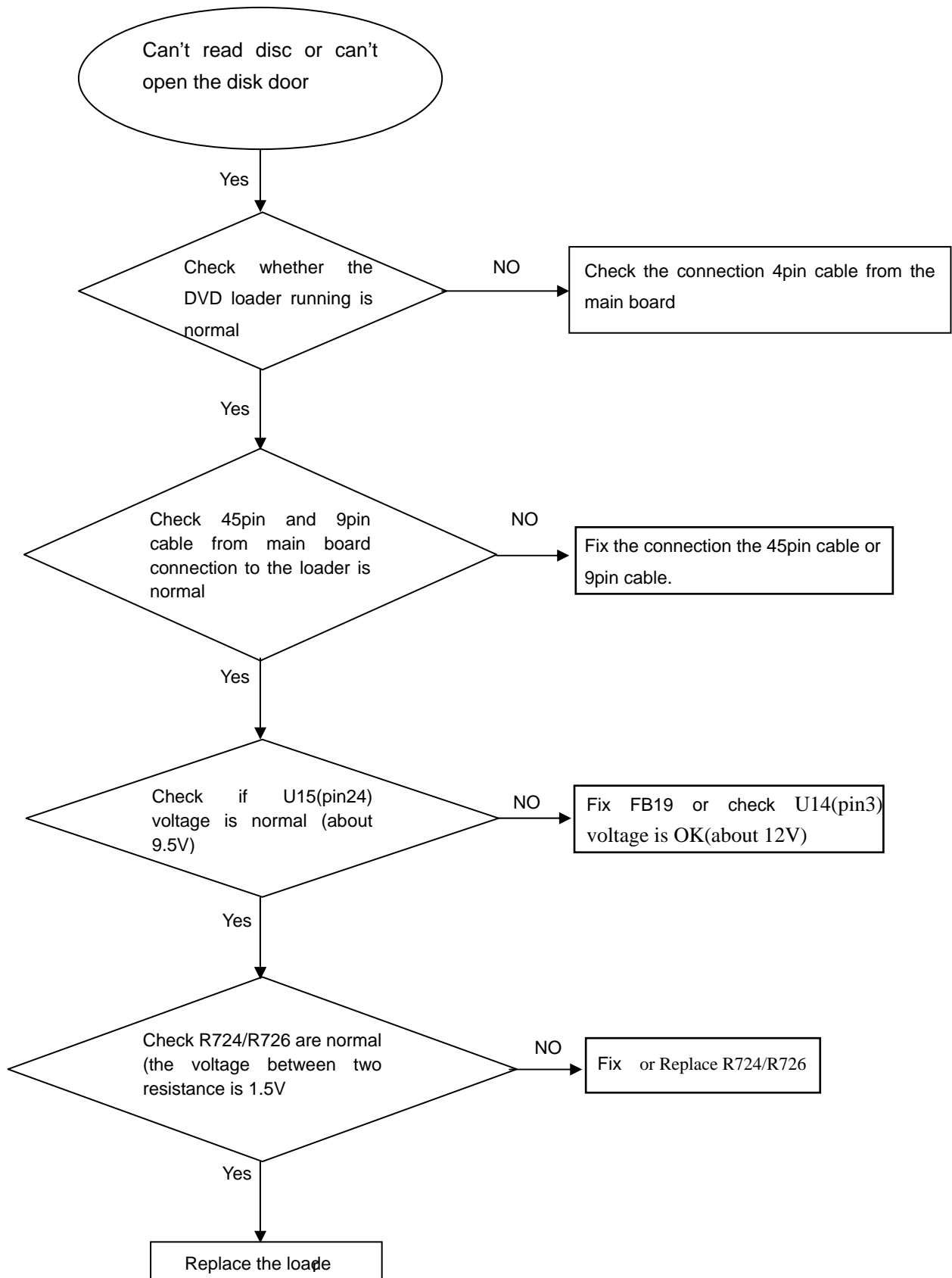

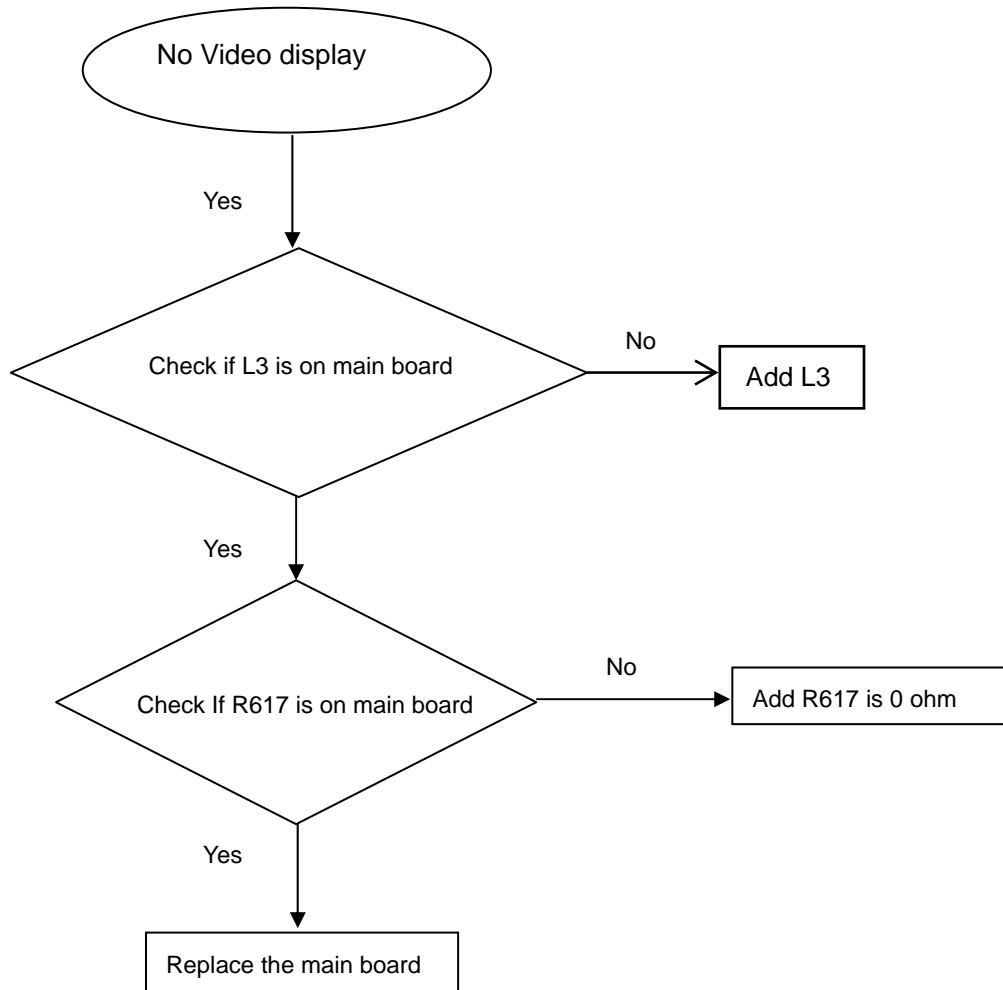
No video display

Can not connect to network

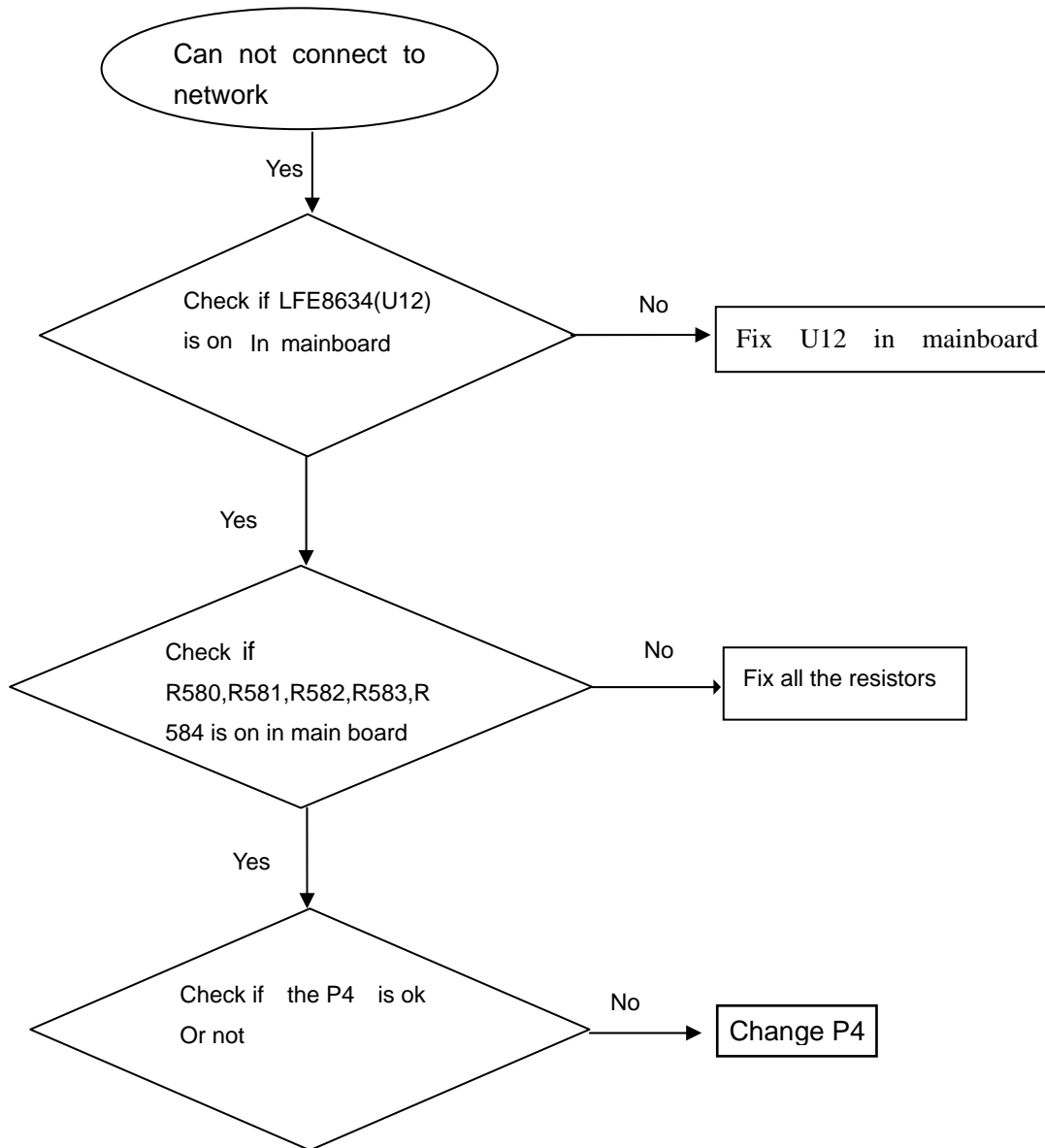

Can not connect to WIFI

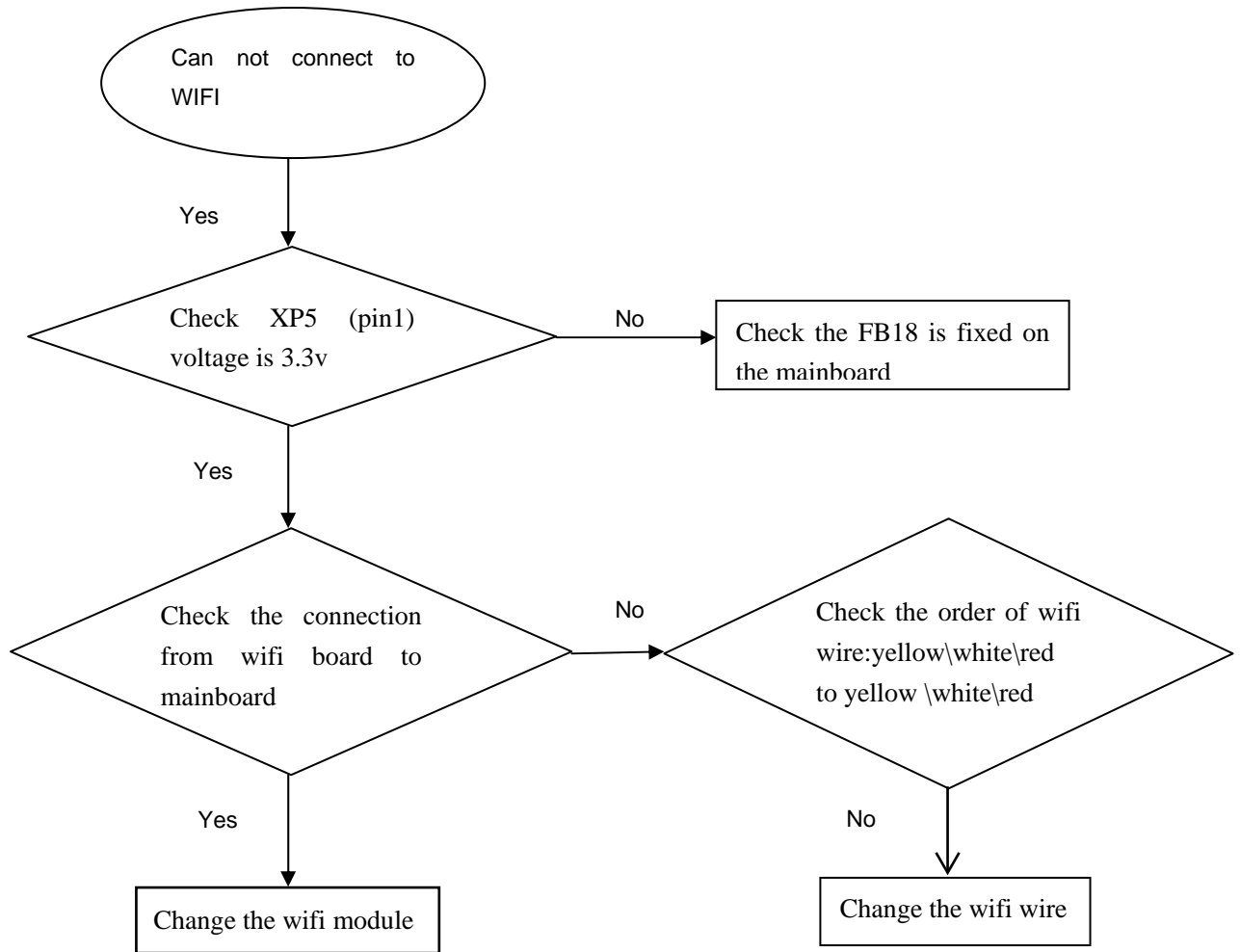

BDP6100/12 Block Diagram:

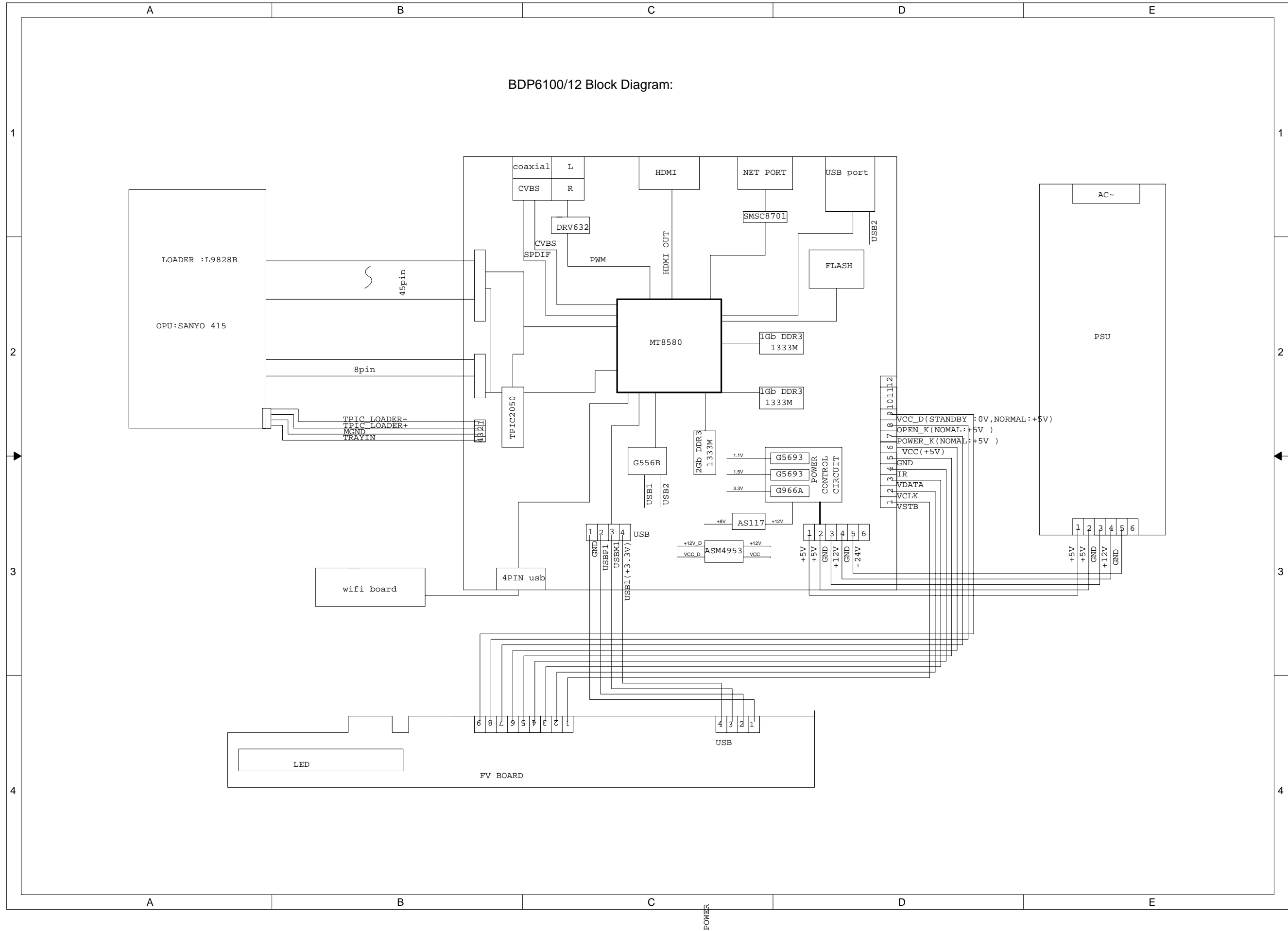

POWER

Front Board Circuit Diagram:

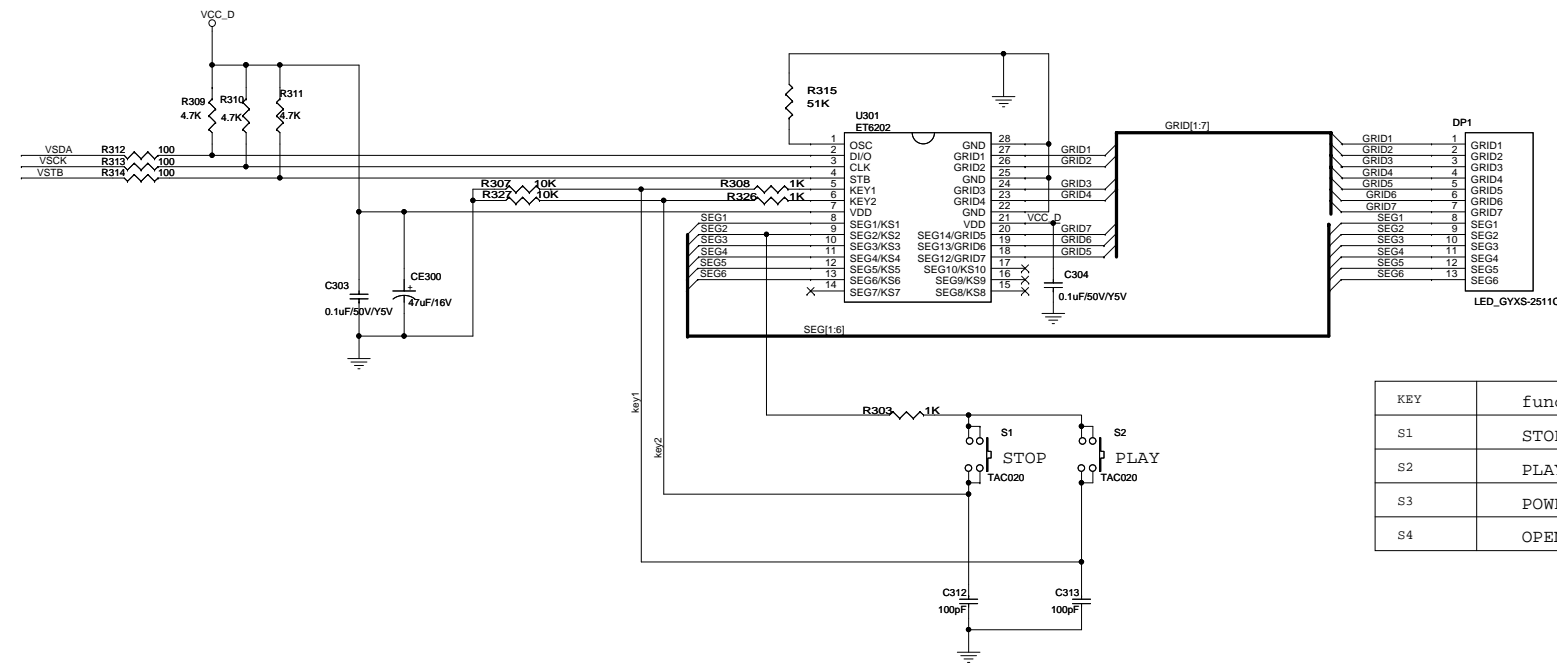
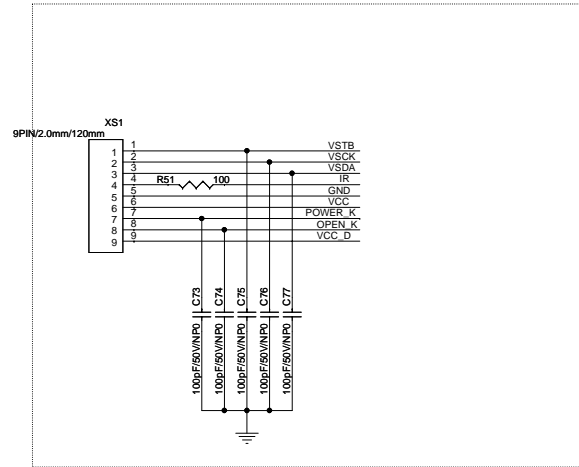
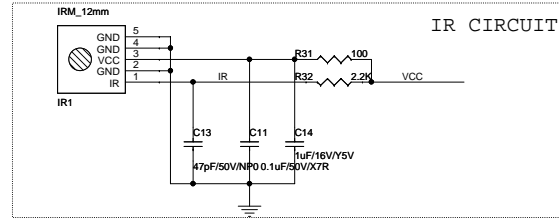

KEY	functional
S1	STOP
S2	PLAY/PAUSE
S3	POWER
S4	OPEN/CLOSE

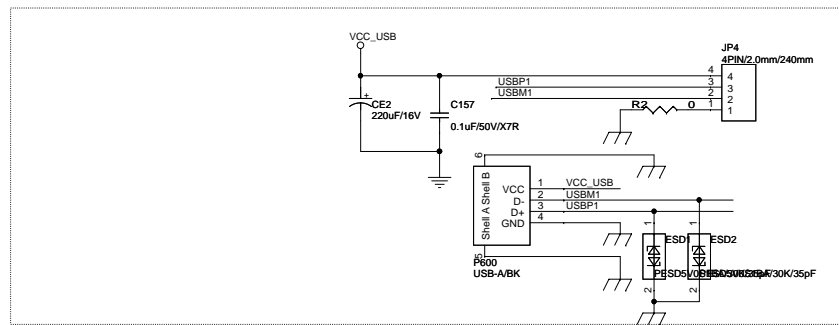
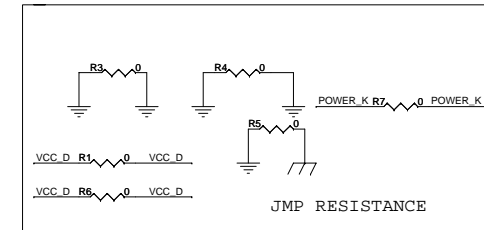
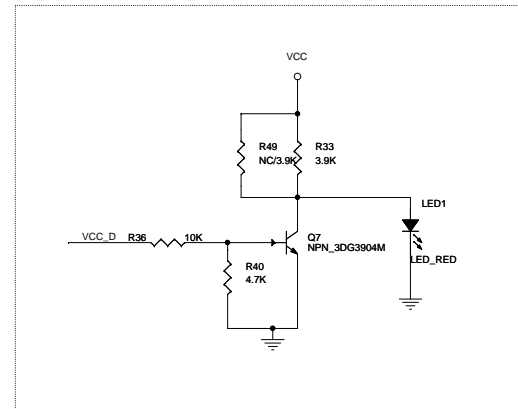
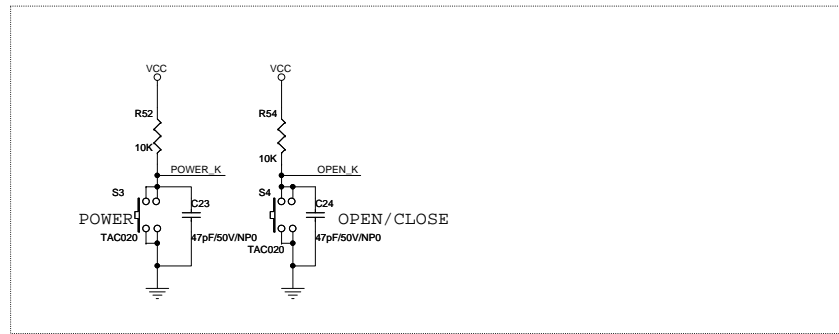

Power Board circuit diagram:

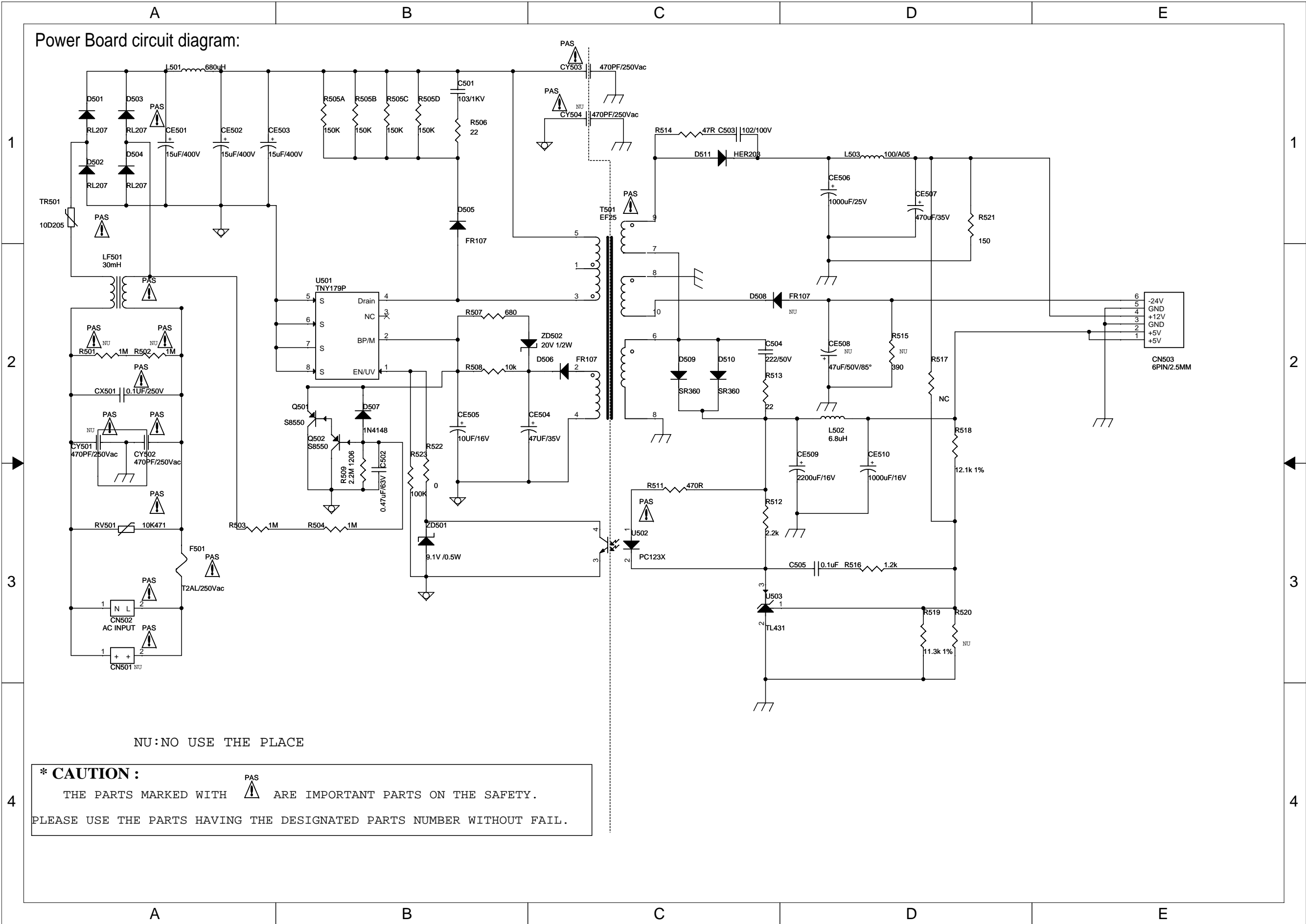

NU:NO USE THE PLACE

*** CAUTION :**

THE PARTS MARKED WITH  ARE IMPORTANT PARTS ON THE SAFETY.
PLEASE USE THE PARTS HAVING THE DESIGNATED PARTS NUMBER WITHOUT FAIL.

Front Board Print-layout (Bottom side):

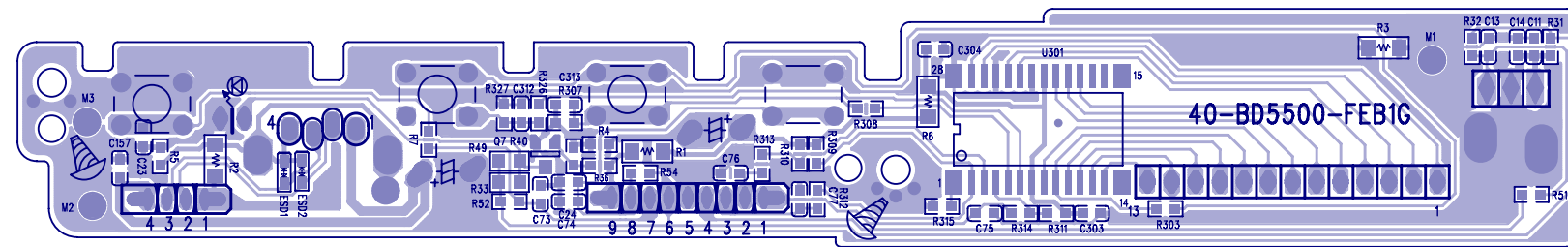

Power Board Print-layout (Bottom side):

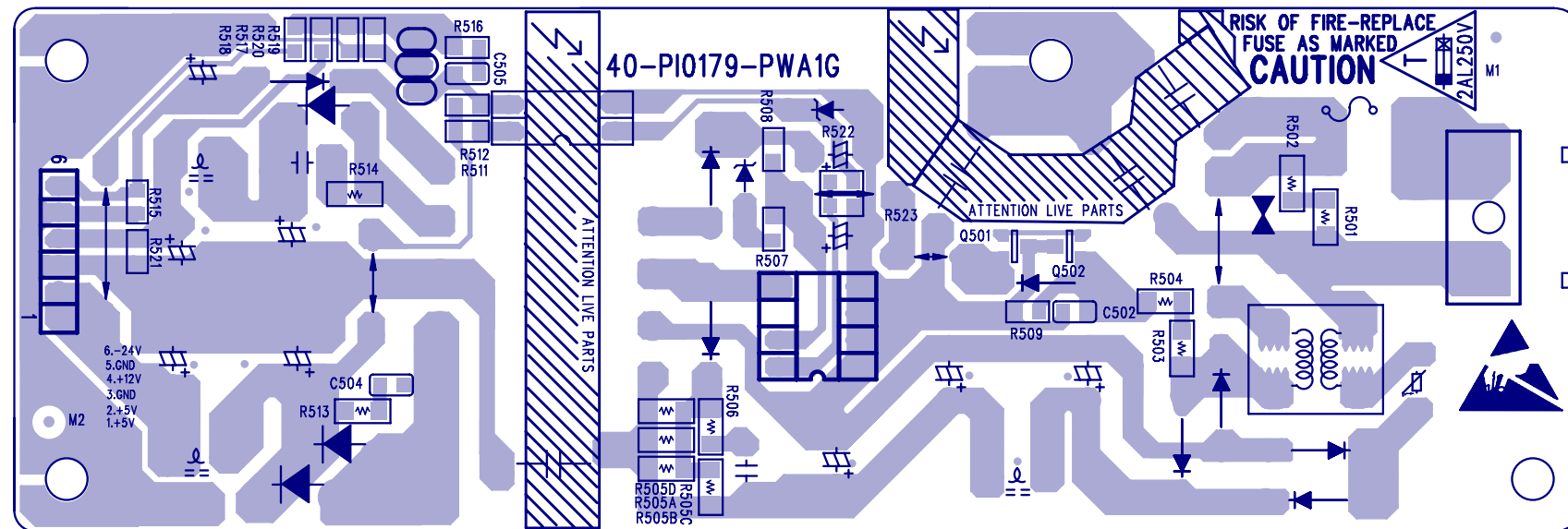

Main Board Print-layout (Top side):

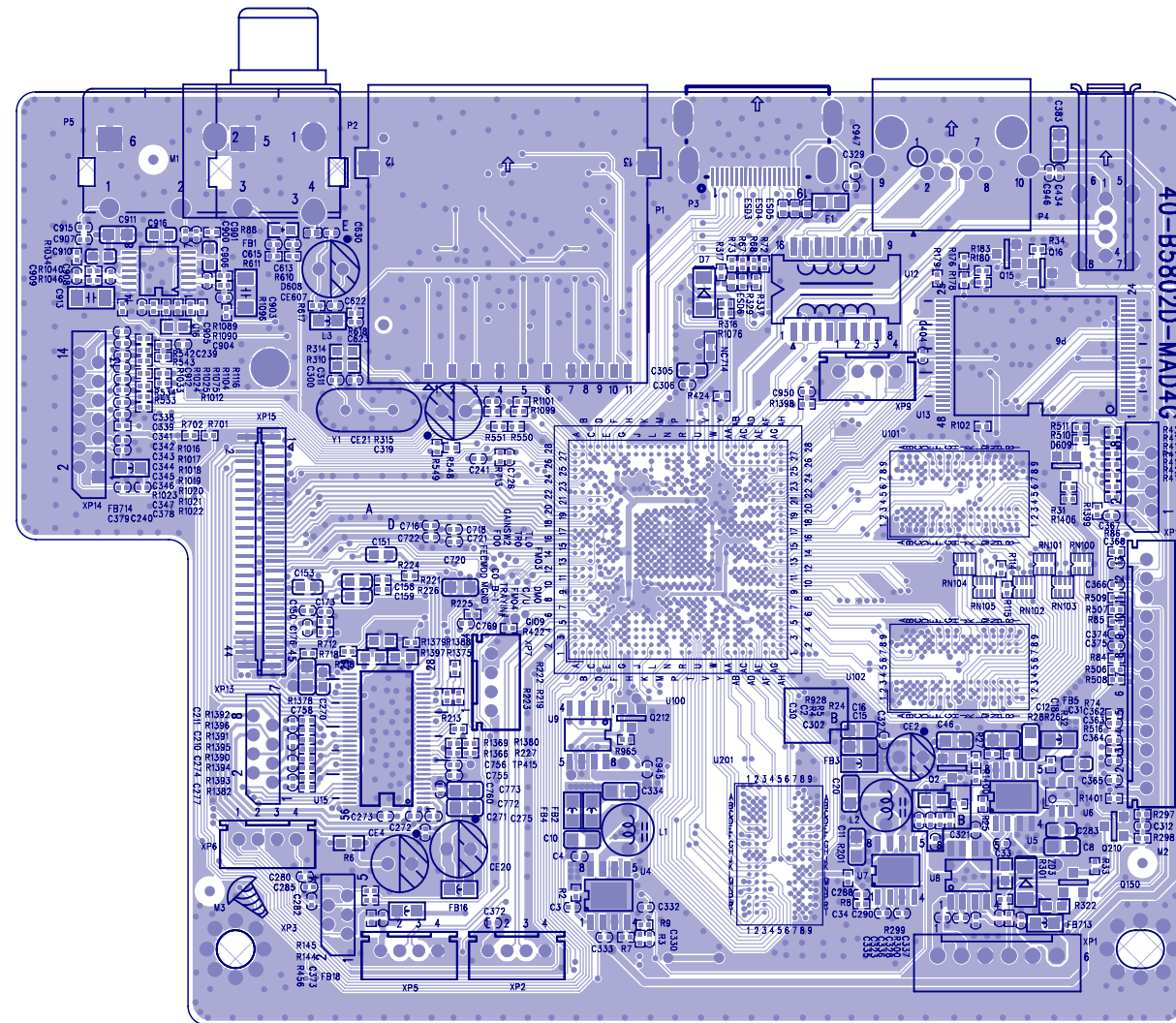

Main Board Print-layout (Bottom side):

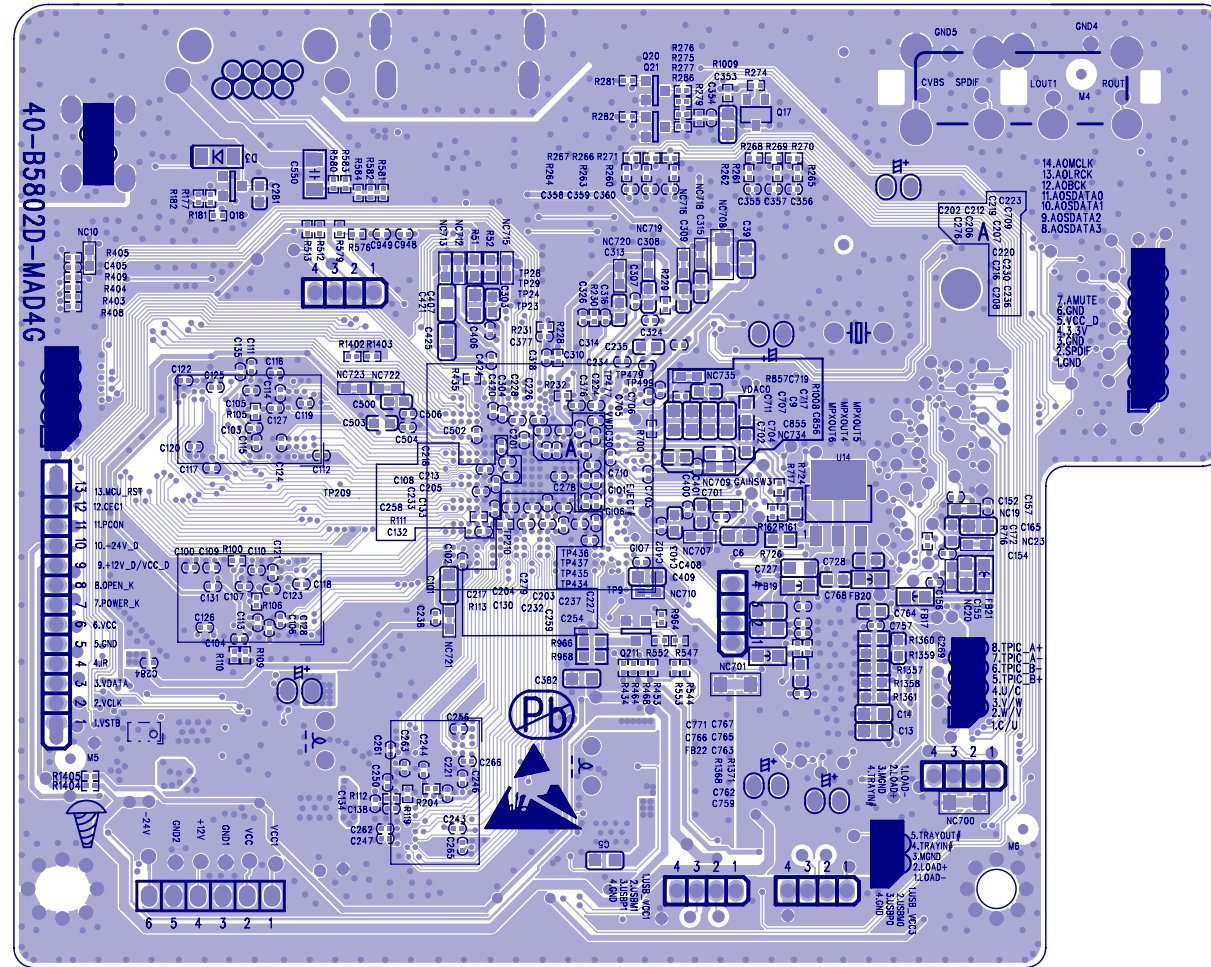

Exploded view for BDP6100/12:

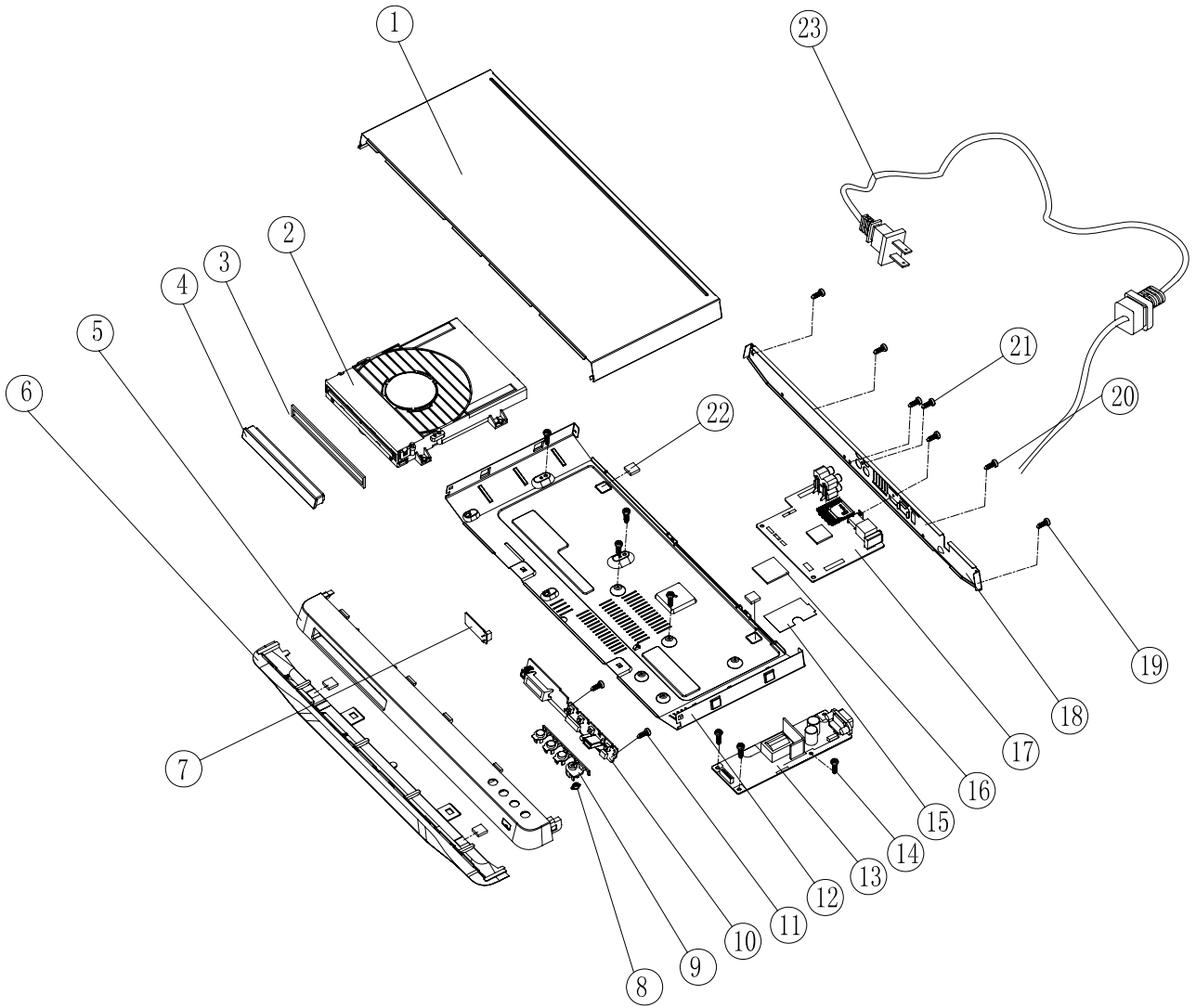

REVISION LIST

Version 1.0

* Initial release for BDP6100/12